

WKO-2C

Active current transformers

Mechanical Data

- Various mounting options with pluggable bases
- The multi-purpose mounting system means that the units can be used easily in new designs and in retro-fit applications
- Various connection possible

WKO-2C									
Type	b1 [mm]	b2 [mm]	t [mm]	s [mm]	h [mm]	D Ø [mm]	D1/D2 [mm]	Ø f [mm]	Ø e [mm]
WKO-2C-300	57	70	38	57	70	30,2	10,4/30,4	4,3	4,3
WKO-2C-500	57	70	38	57	70	30,2	10,4/30,4	4,3	4,3
WKO-2C-1000	78	94	42	78	94	38,5	13,5/40,5	5,3	5,3
WKO-2C-2000	102	135	52	102	135	57,5	20,5/60,5	6,5	6,5

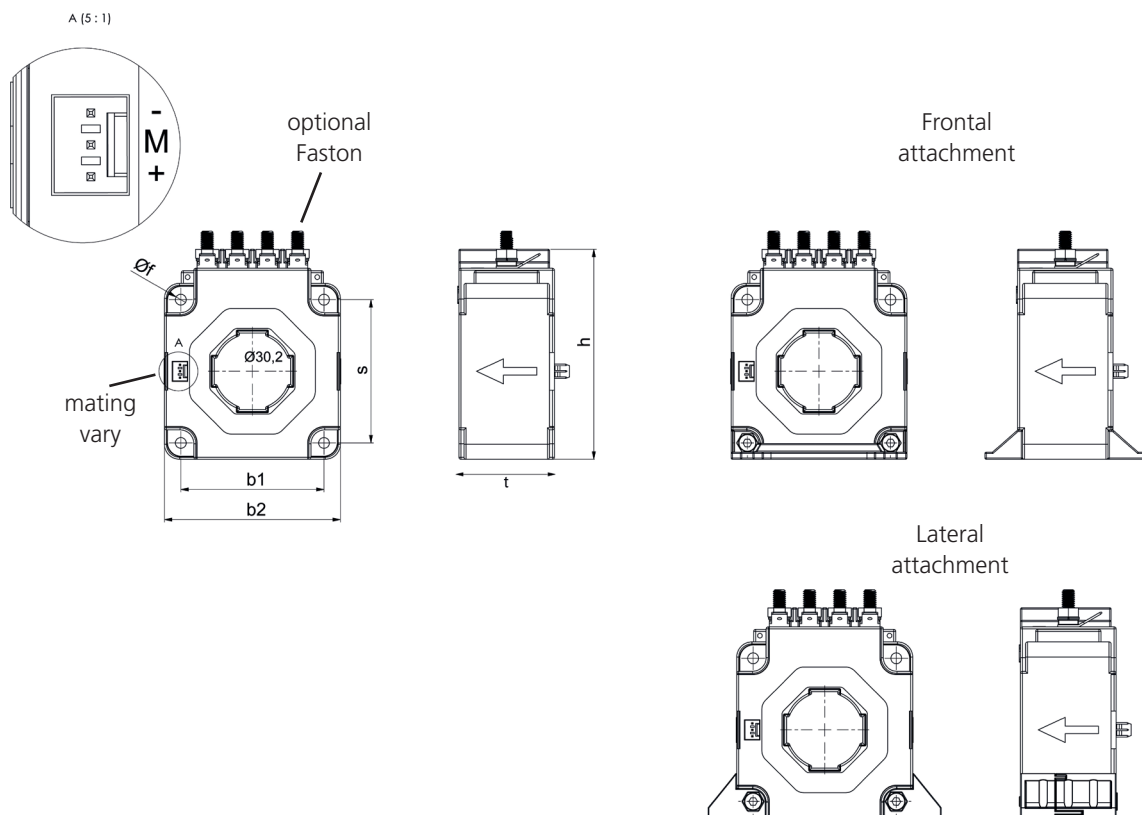

WKO-2C

Active current transformers

WKO-2C
Basic model with
Molex plug



WKO-2C-F
Basic model with Molex plug
and mounting feet frontal



WKO-2C-FG
Basic model with Molex
plug and mounting feet
frontal, fitted on the left



WKO-2C-L
Basic model with Molex
plug and mounting feet
lateral

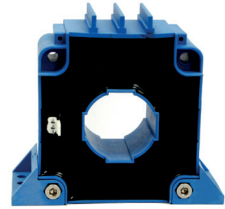

WKO-2C-A
Basic model with
front cover



WKO-2C-A-F
Basic model with front
cover and mounting feet
frontal



WKO-2C-A-L
Basic model with front
cover and mounting feet
lateral

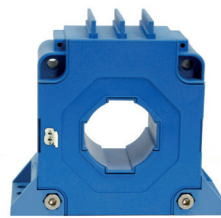

WKO-2C-A-K
Model with front cover
and litz wires

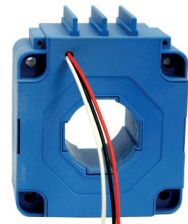

WKO-2C-A-K-F
Model with front cover,
litz wire and mounting
feet frontal

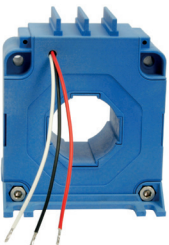

WKO-2C-A-K-L
Model with front cover,
litz wire and mounting
feet lateral

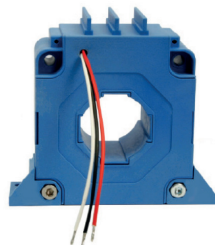

WKO-2C-A-K-FG
Model with front cover,
litz wire and mounting
feet frontal fitted on the
left

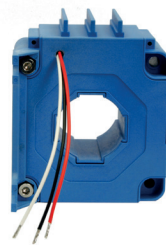

WKO-2C-A-S-F
Model with front cover
and litz wire with plug,
with mounting feet
frontal



WKO-2C-B
Basic model with Faston
plugs and bolts and front
cover



WKO-2C-B-F
Basic model with Faston
plugs, front cover and
mounting feet frontal



WKO-2C-B-L
Basic model with Faston
plugs, front cover and
mounting feet lateral



WKO-2C-B-M
Basic model with faston
plugs, pins and front
cover as well as mounting
attachment for conductor
rail



WKO-2C-B-M-F
Basic model with faston
plugs, bolts, front cover
and mounting attach-
ment for conductor rail
and mounting feet frontal



WKO-2C-B-M-FR
Basic model with Faston
plugs, front cover and
mounting kit for busbar
and mounting feet frontal,
fitted on the right



WKO-2C-B-M-L
Basic model with Faston
plugs, front cover and
mounting kit for busbar
and mounting feet lateral



WKO-2C-B-M-F-C
Basic model with Faston
plugs, front cover and
mounting kit for busbar
and mounting feet frontal
and busbar



Fastenings optionally available for mounting to the basic model

C
Copper busbar



L
1 set of mounting feet
lateral (2 left, 2 right)



F
1 set of mounting feet
frontal (2 pcs)



A
Front cover



M
Mounting kit for busbar

